



**BEZVA POSTELE**

# MONTÁŽNÍ NÁVOD

Postel s vysokou bočnicí typu box,  
klasické přední nohy

[bezvapostele.cz](http://bezvapostele.cz)

Postel s latěmi	Str. 2-14
Postel s hřebeny	Str. 15-27

# MONTÁŽNÍ NÁVOD

## Postel s latěmi

Tato část návodu se věnuje variantě postele s latěmi. Pokud jste zakoupili variantu postele s hřebeny, pokračujte prosím od strany 15. tohoto návodu.

# ČÁSTI POSTELE

SE STŘEDOVOU LATÍ

140x200
160x200
180x200
200x200

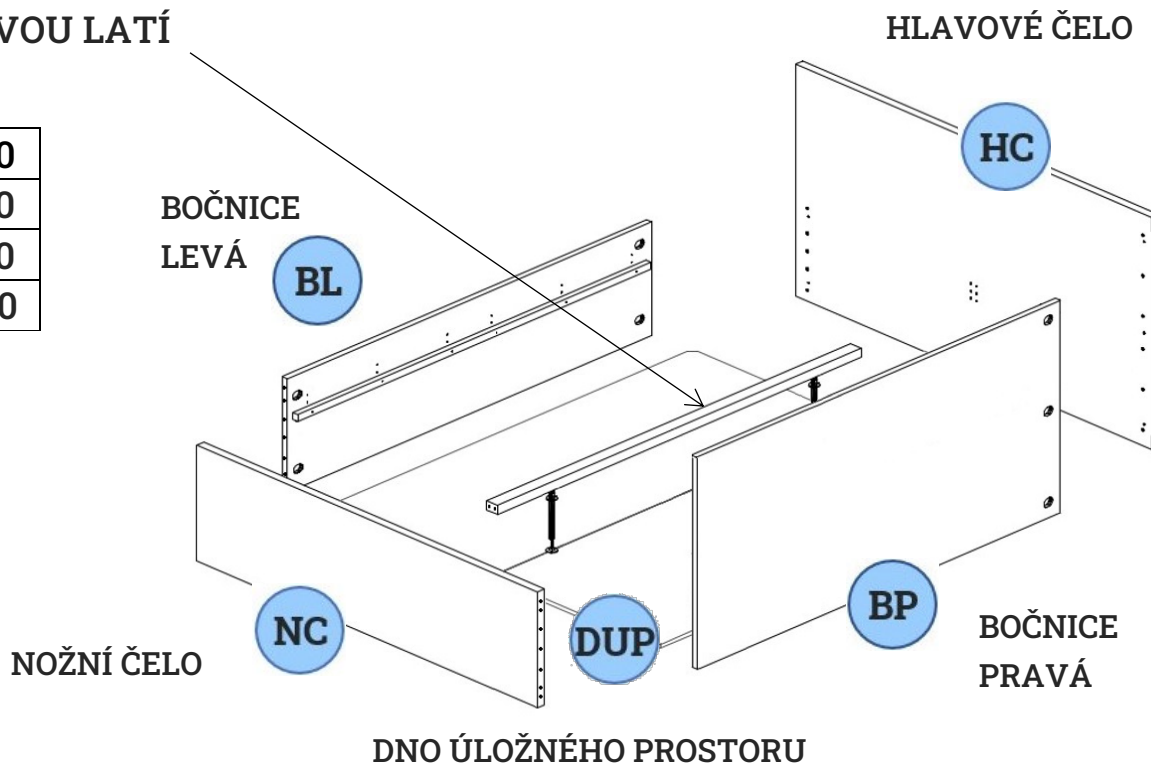

BEZ STŘEDOVÉ LATĚ

80x200
90x200
100x200
110x200
120x200
130x200

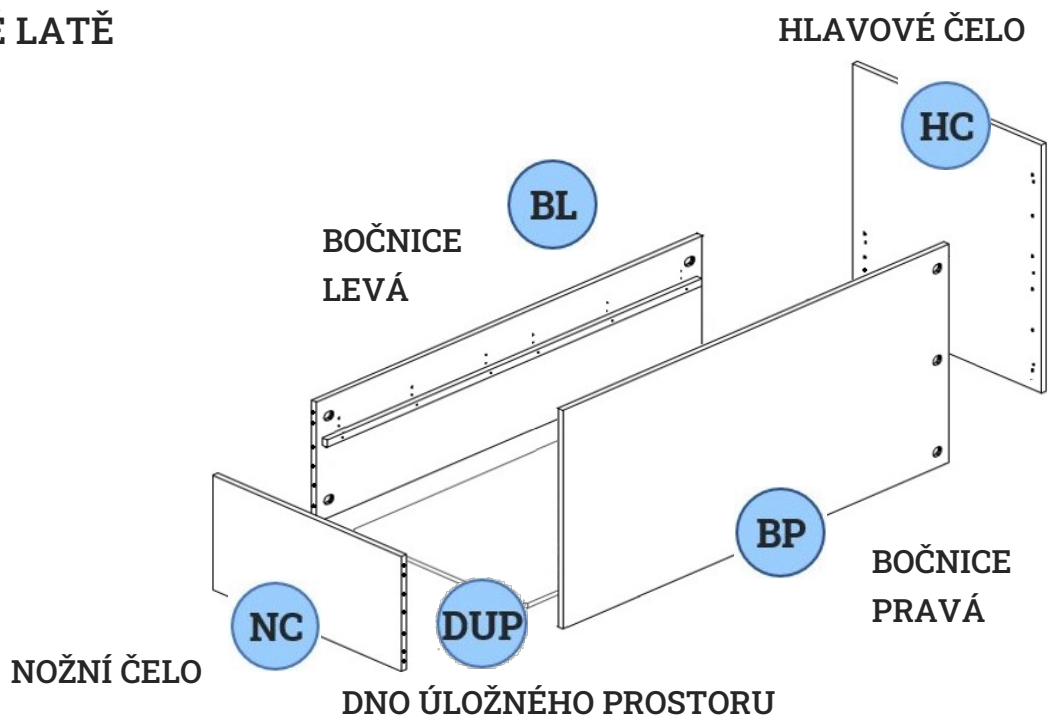

LATĚ DO BOČNIC

LB

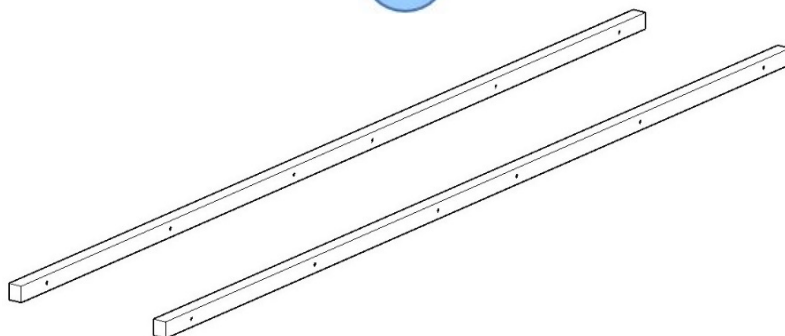

STŘEDOVÁ LAŤ

SL

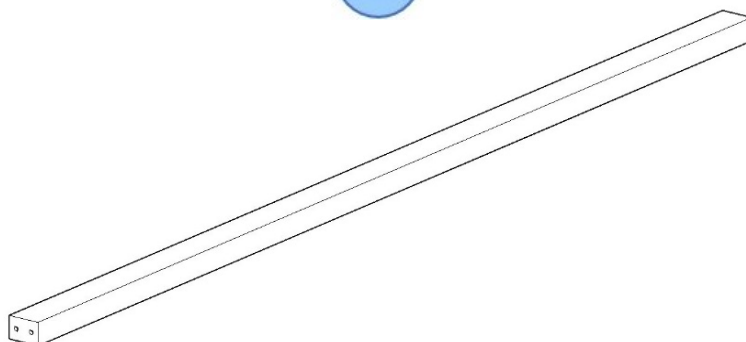

DNO ÚLOŽNÉHO PROSTORU

DUP

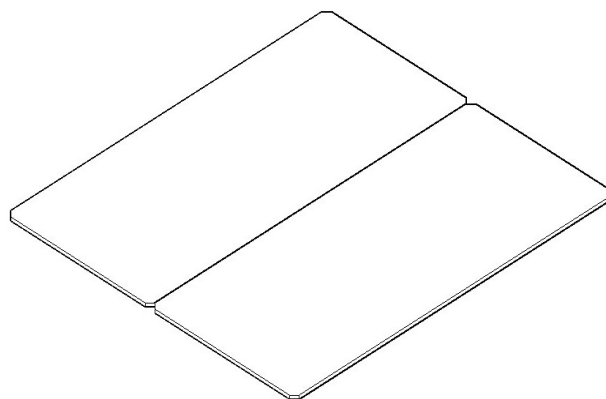

Obrázky uvedené níže jsou ilustrační, design Vaší postele se může lišit.

### PŘÍKLAD BOČNICE PRAVÉ

BP

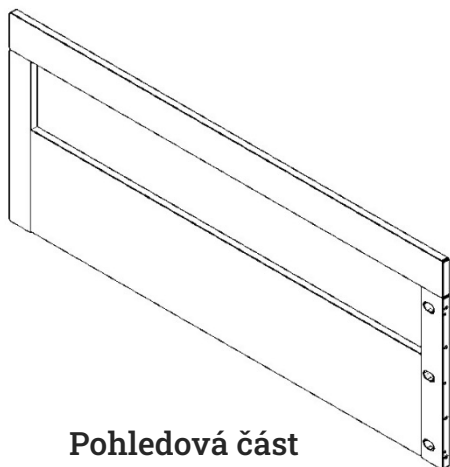

Pohledová část

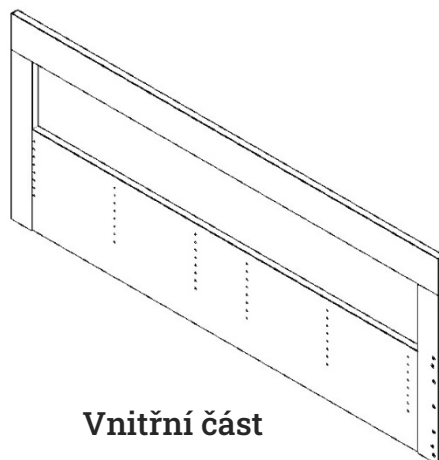

Vnitřní část

### PŘÍKLAD BOČNICE PRAVÉ

BP

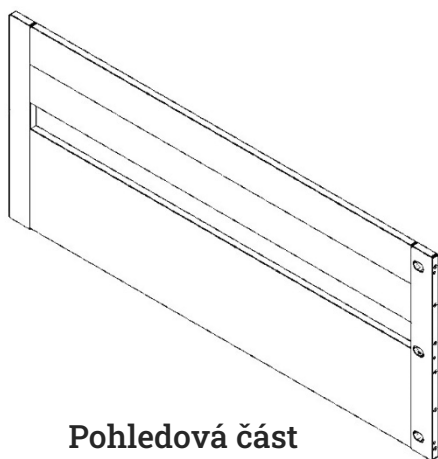

Pohledová část

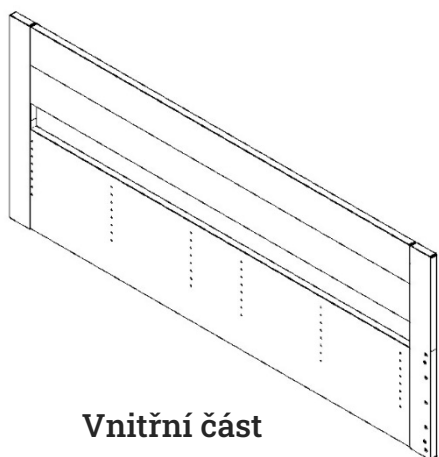

Vnitřní část

### PŘÍKLAD BOČNICE LEVÉ

BL

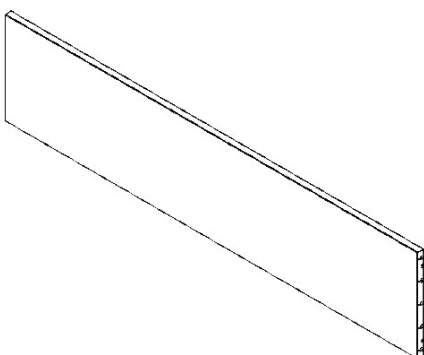

Pohledová část

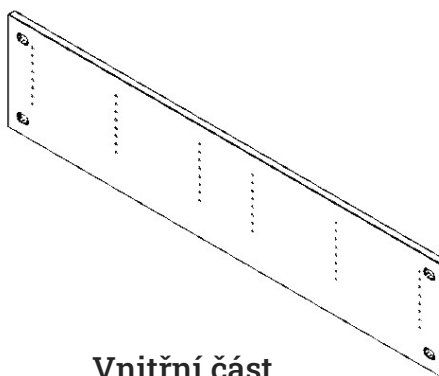

Vnitřní část

### PŘÍKLAD NOŽNÍHO ČELA

NC

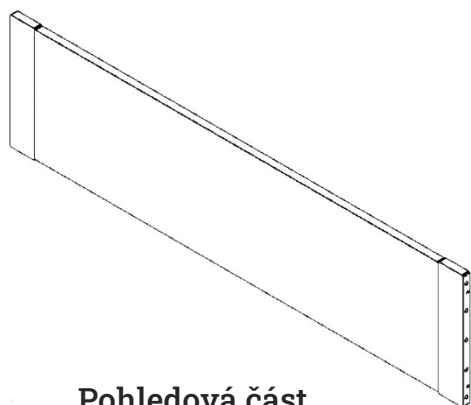

Pohledová část

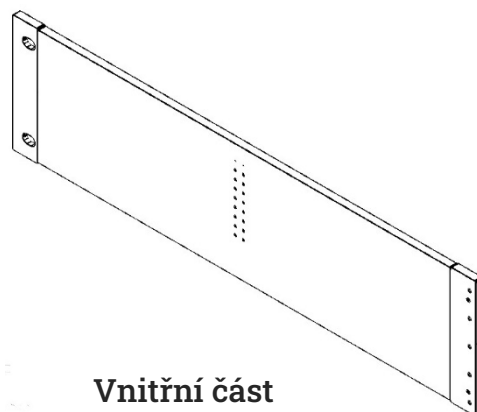







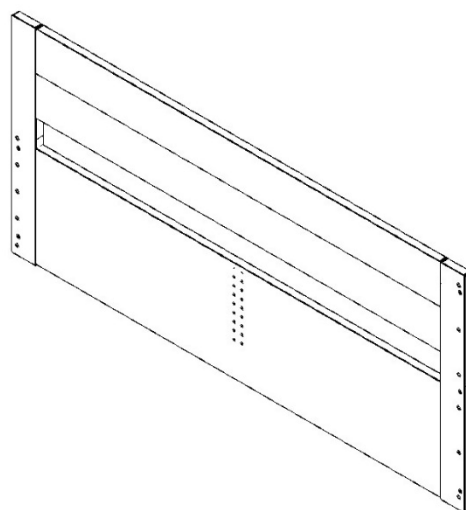
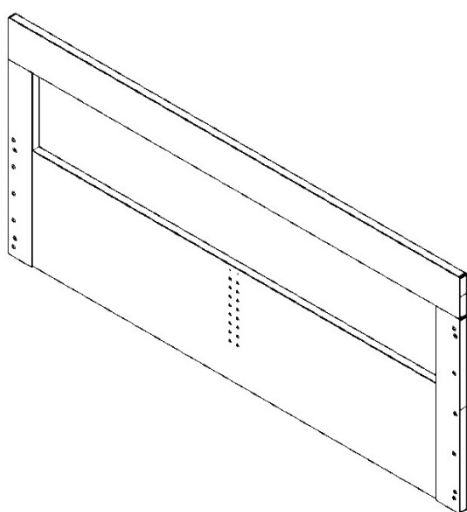



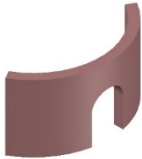

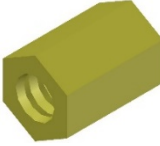
Vnitřní část

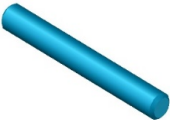
### PŘÍKLAD HLAVOVÉHO ČELA

HC

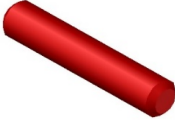
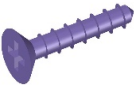

# SOUPIS KOVÁNÍ

 <p><b>1</b> 9 ks</p>	 <p><b>2</b> 9 ks</p>	 <p><b>3</b> 9 ks</p>	 <p><b>4</b> 9 ks</p>
 <p><b>5</b> Ø 8x40 4 ks</p>	 <p><b>6</b> TORX 7x45 12 ks</p>	 <p><b>7</b> 2 ks</p>	 <p><b>8</b> 2 ks</p>
 <p><b>9</b> Ø 12 8-26 ks</p>	 <p><b>10</b> 4x20 4 ks</p>	 <p><b>11</b> 4x30 4 ks</p>	 <p><b>12</b> KLÍČ TORX 1 ks</p>
 <p><b>13</b> 1 ks</p>			

# SESTAVENÍ POSTELE

# 1.

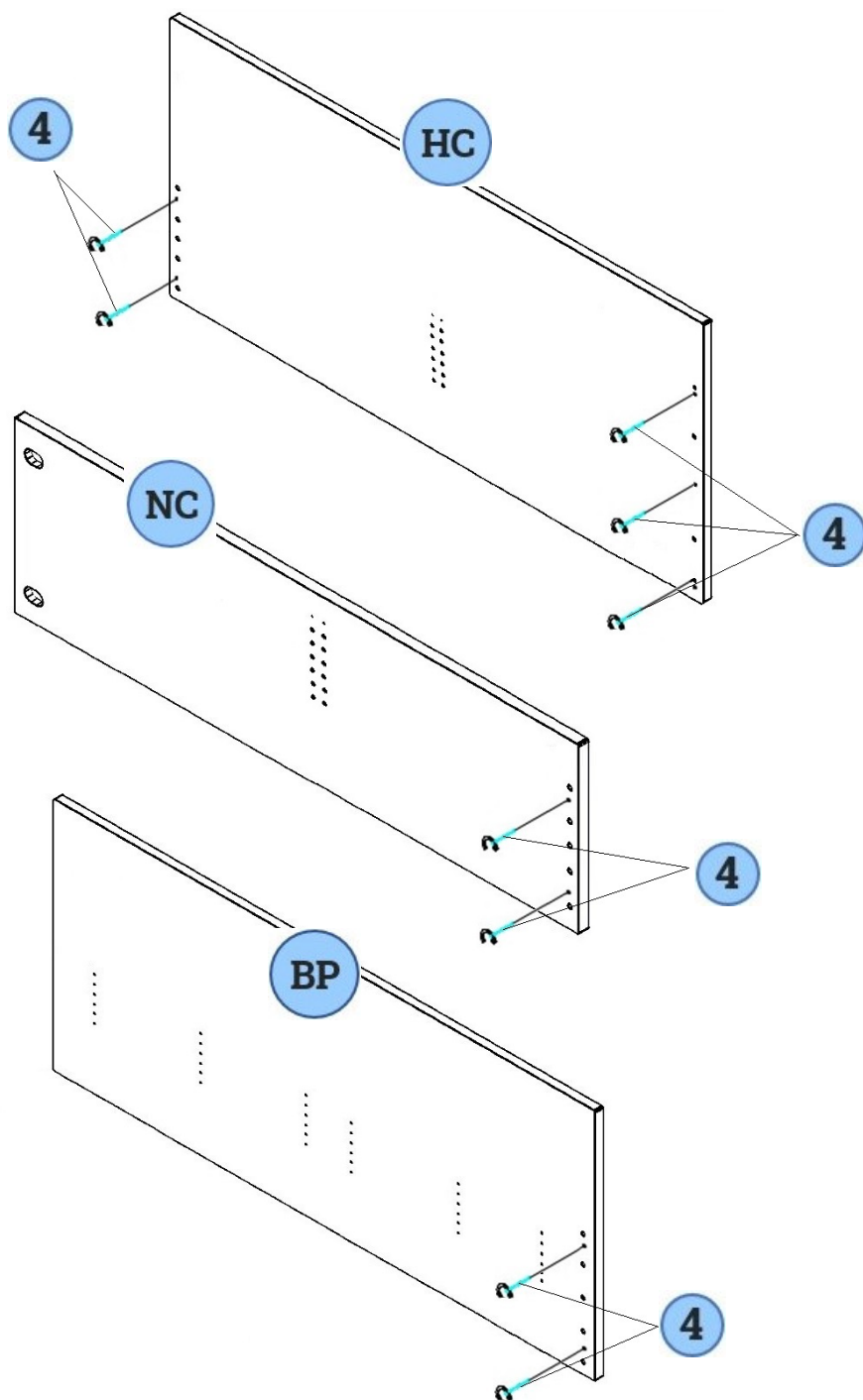

**HC**

1 ks

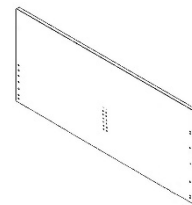

**NC**

1 ks

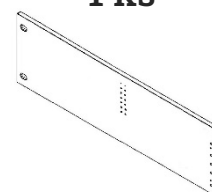

**BP**

1 ks

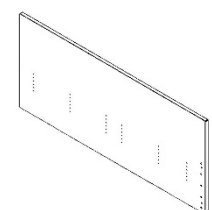

**4**

9 ks





# 2.

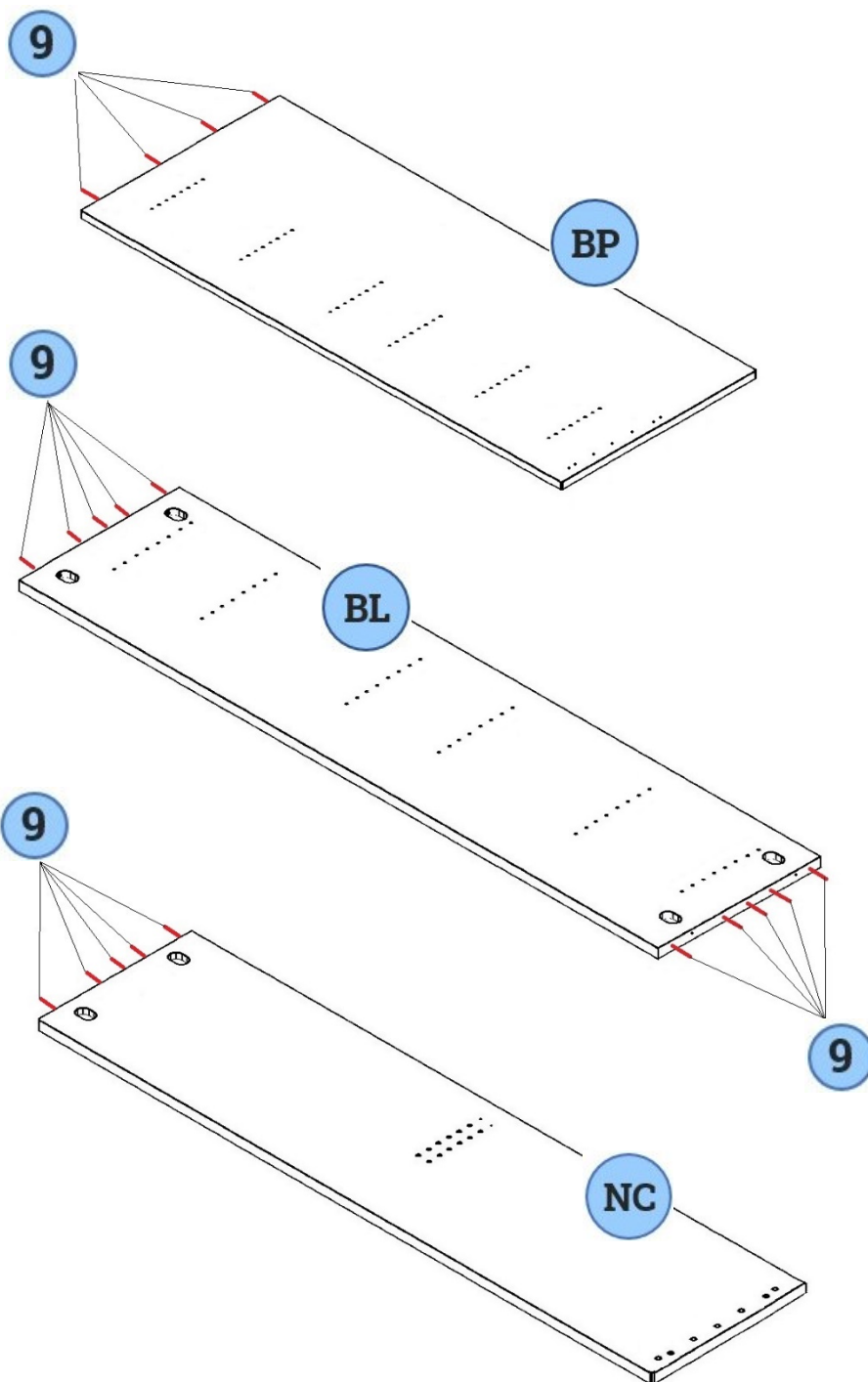

**BP**

1 ks

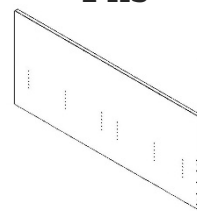

**BL**

1 ks

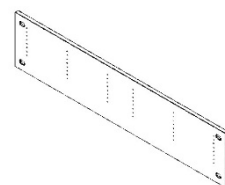

**NC**

1 ks

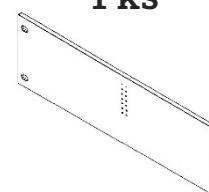

**9**

8-26 ks

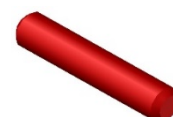

# 3.

Pokud máte postel šířky 90-130 cm, tento krok přeskočte.

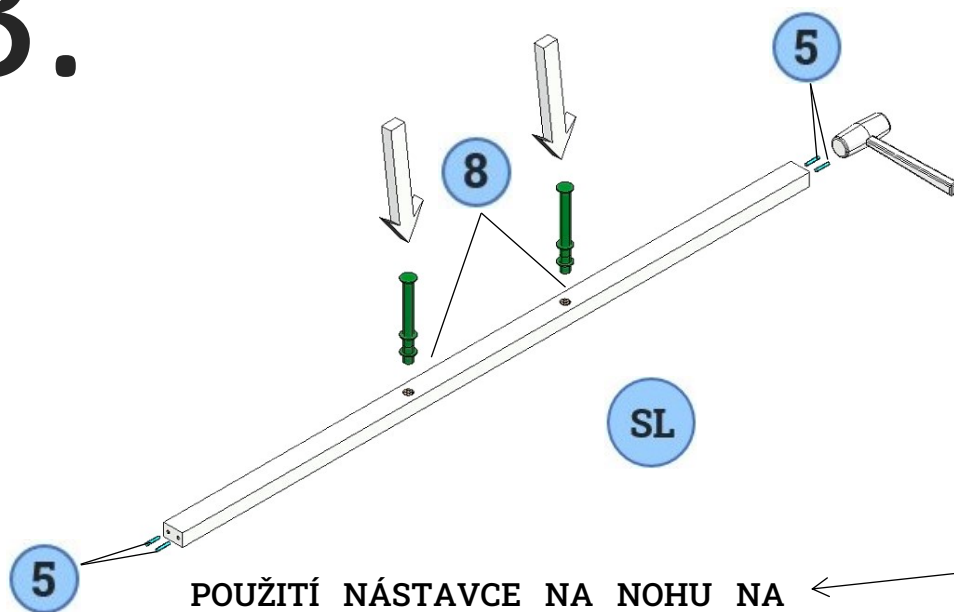

POUŽITÍ NÁSTAVCE NA NOHU NA ZÁKLADĚ VÝŠKOVÉHO UMÍSTĚNÍ LATÍ

SL

1 ks

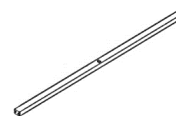

5

4 ks

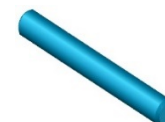

8

2 ks



# 4.

V tomto kroku dobře zvažte, v jaké výšce bude umístěna středová lat' (viz. schéma výšky latí níže na této straně). V případě postele šířky 90-130 cm krok umístění středové latě přeskočte.

## Schéma výšky latí

Latě do bočnic a středovou lat' můžete připevnit do několika pozic. Výšková pozice latí ovlivňuje tyto dvě věci:

- 1) Výslednou výšku ložné plochy (pozor, berte v potaz i výšku roštu).
- 2) Kolik cm matrace bude zapuštěno v rámu postele (doporučujeme minimálně 5-8 cm).

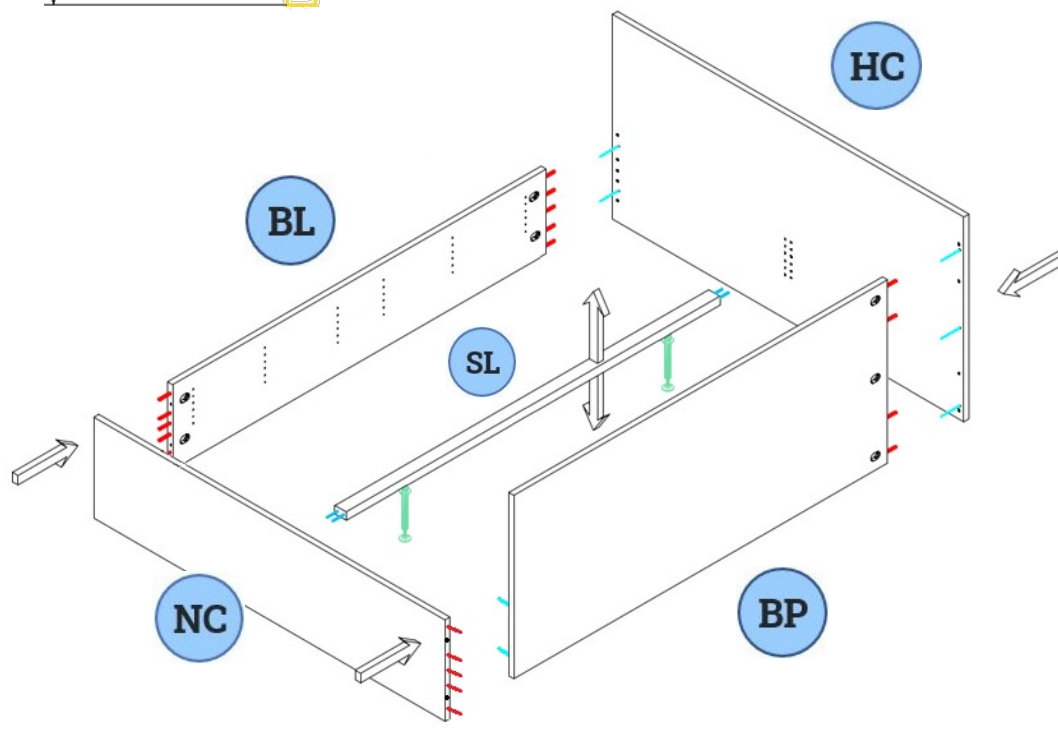
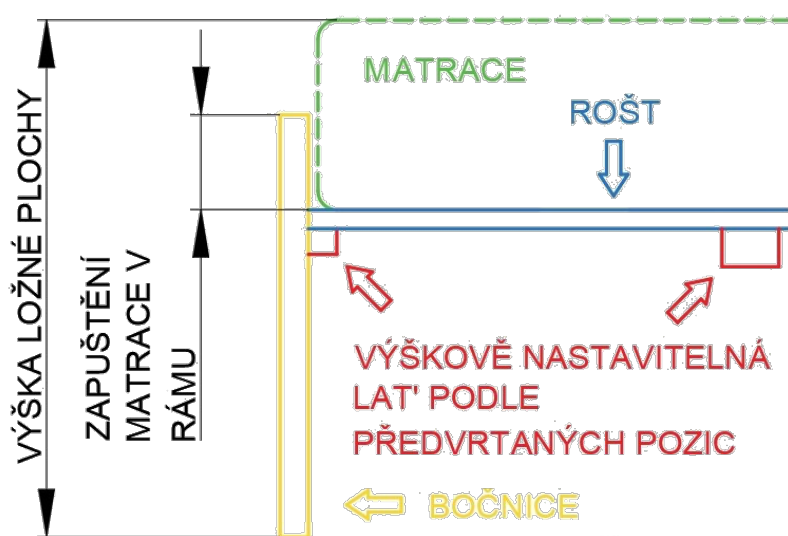

HC

1 ks

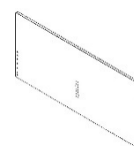

NC

1 ks

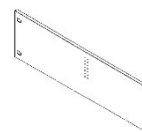

BP

1 ks

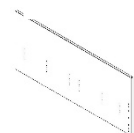

BL

1 ks

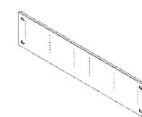

SL

1 ks

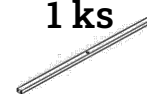

# 5.

Před stažením šroubového spoje pečlivě zkontrolujte, že k sobě dílce bočnice a čela postele dokonale doléhají. V případě nutnosti použijte gumovou paličku. Až poté je možné šroubový spoj dotáhnout.

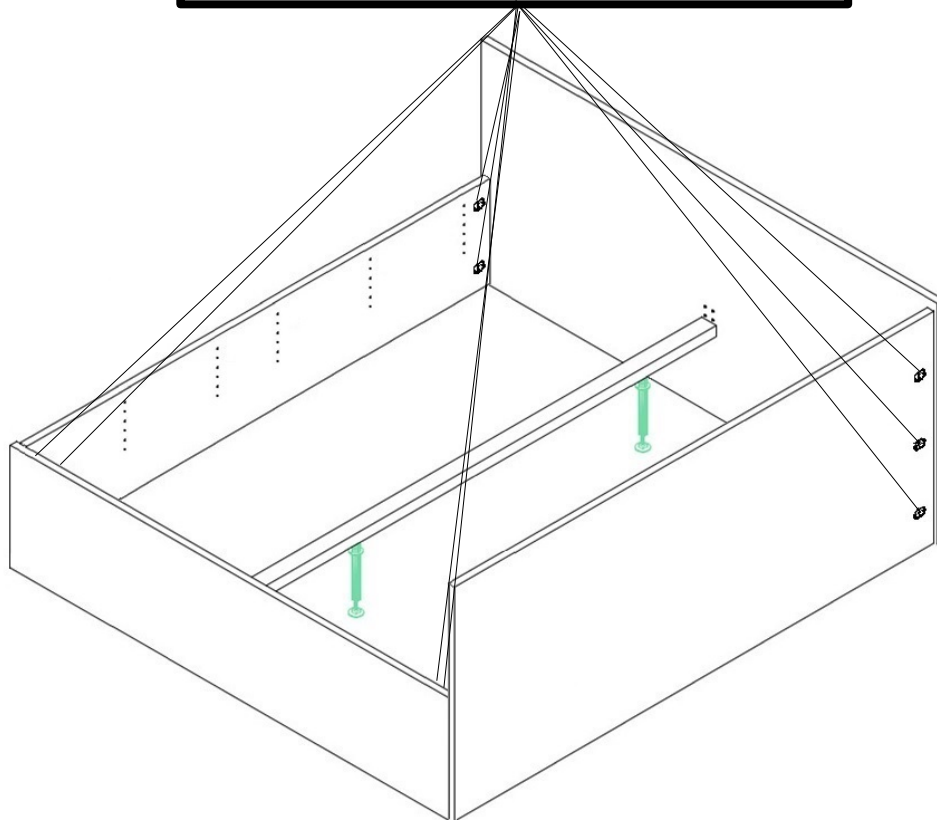
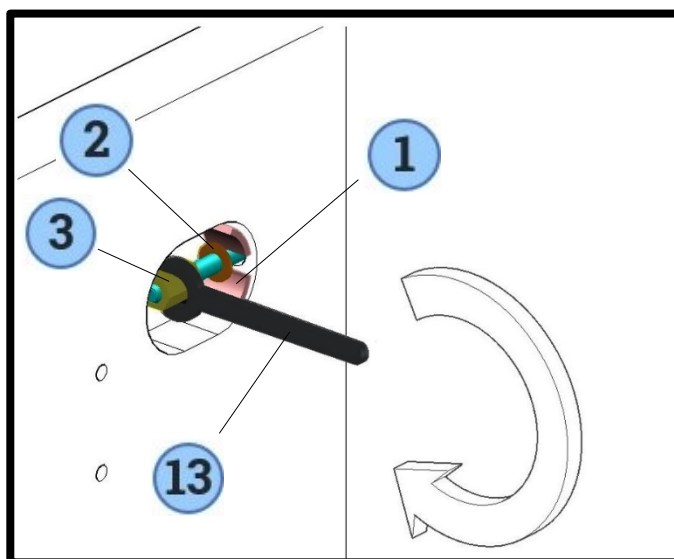

1

9 ks



2

9 ks



3

9 ks



13

1 ks



# 6.

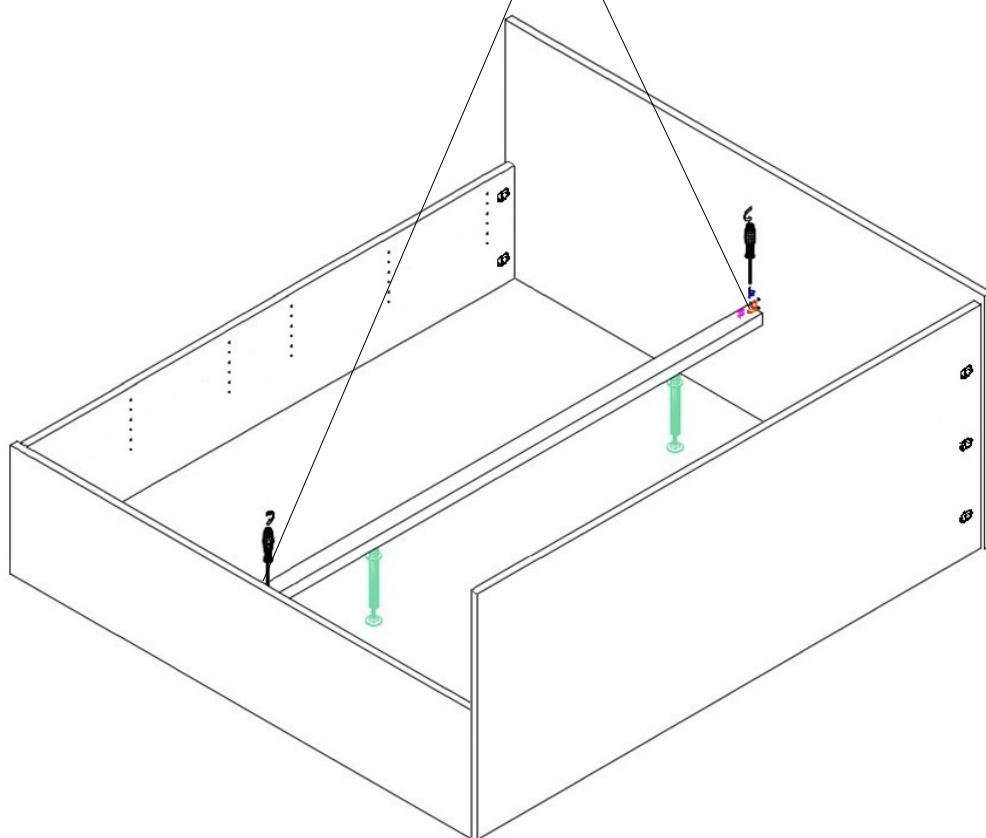
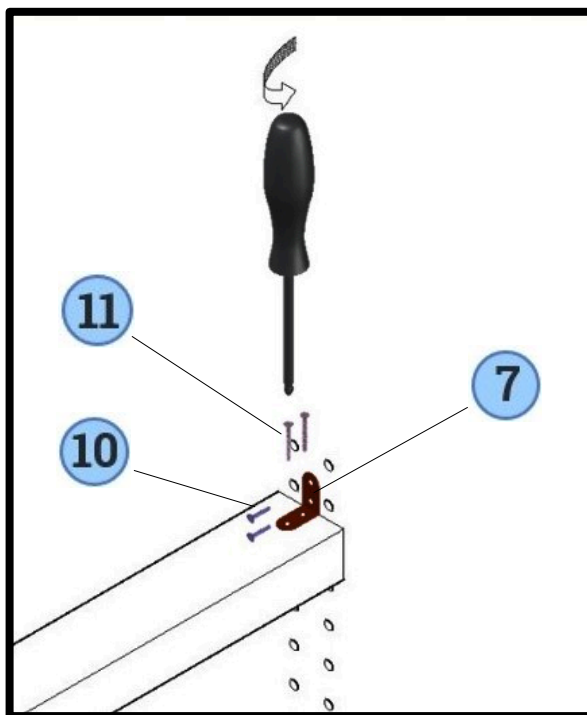

10

4 ks



11

4 ks



7

2

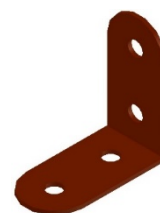

- 7** V tomto kroku dobře zvažte, v jaké výšce bude umístěna středová lat' (viz. schéma výšky latí níže na této straně). V případě postele šířky 90-130 cm krok umístění středové latě přeskočte.

### Schéma výšky latí

Latě do bočnic a středovou lat' můžete připevnit do několika pozic. Výšková pozice latí ovlivňuje tyto dvě věci:

- 1) Výslednou výšku ložné plochy (pozor, berte v potaz i výšku roštu).
- 2) Kolik cm matrace bude zapuštěno v rámu postele (doporučujeme minimálně 5-8 cm).

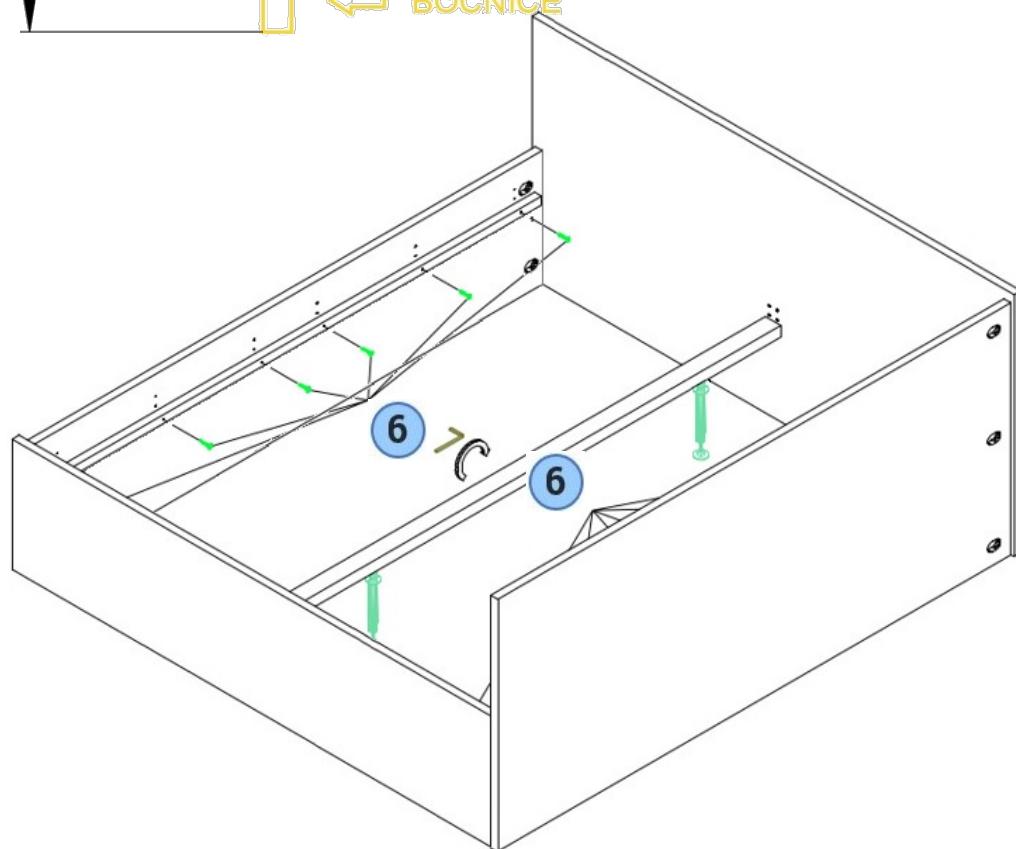
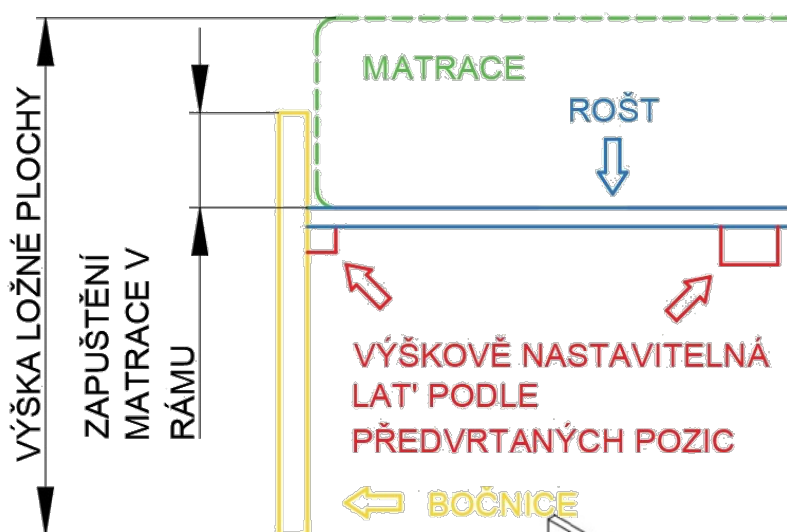

**LB**

2 ks

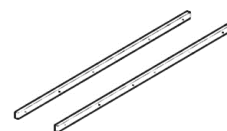

**6**

TORX  
7x45  
12 ks



**12**

KLÍČ  
TORX  
1 ks



# MONTÁŽNÍ NÁVOD

## Postel s hřebeny

Tato část návodu se věnuje variantě postele s hřebeny. Pokud jste zakoupili variantu postele s latěmi, vraťte se prosím na stranu 2. tohoto návodu.

## SE STŘEDOVOU LATÍ

140x200
160x200
180x200
200x200

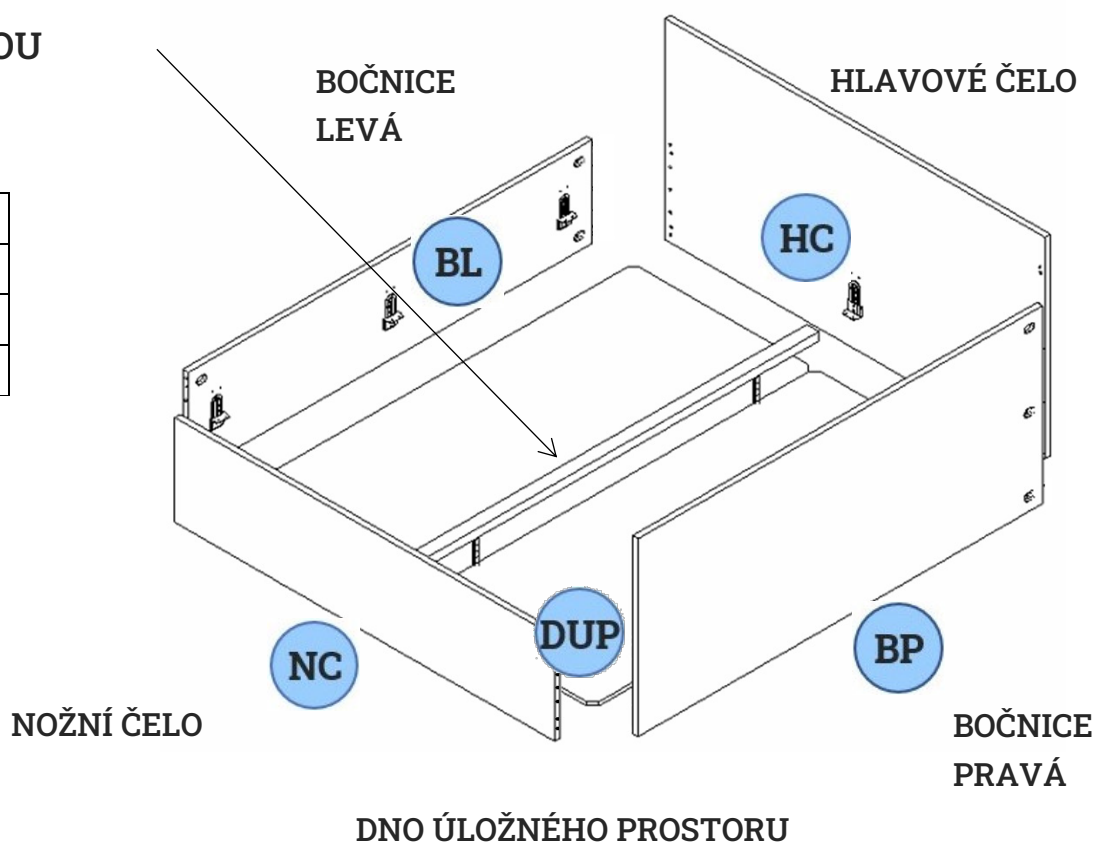

## BEZ STŘEDOVÉ LATĚ

80x200
90x200
100x200
110x200
120x200
130x200

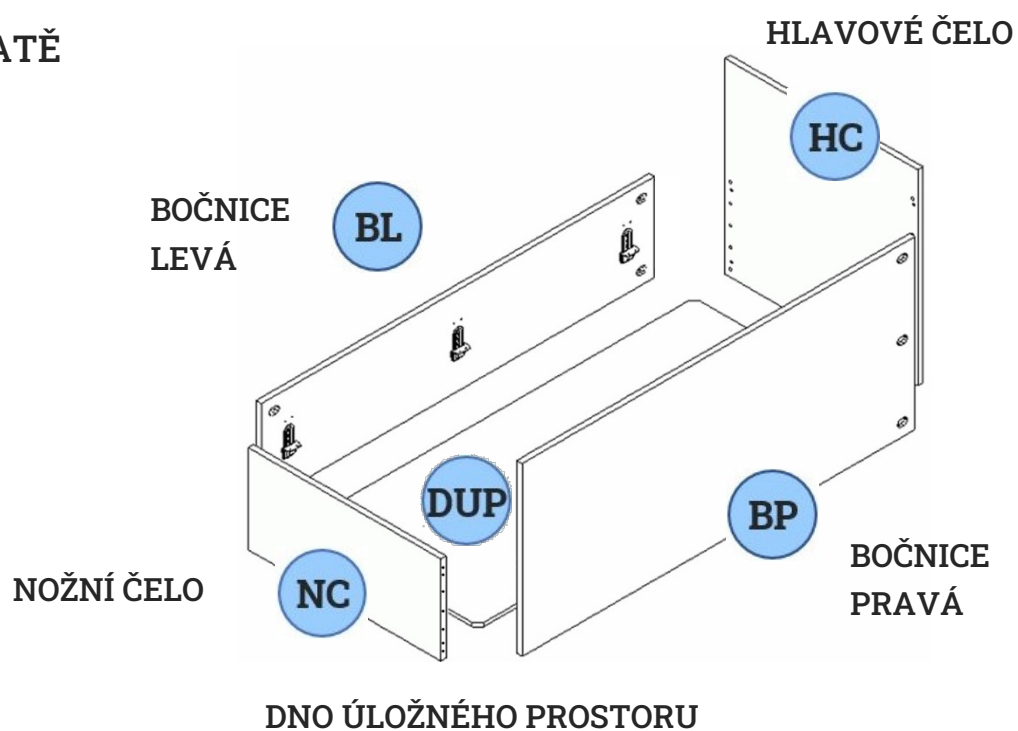





## HÁKY DO BOČNIC

HB

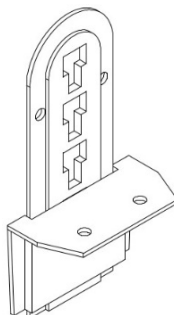

## STŘEDOVÁ LAŤ

SL

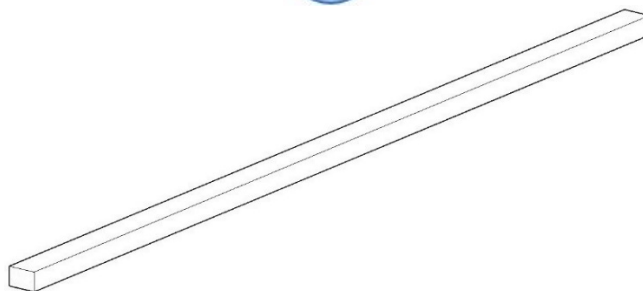

## DNO ÚLOŽNÉHO PROSTORU

DUP

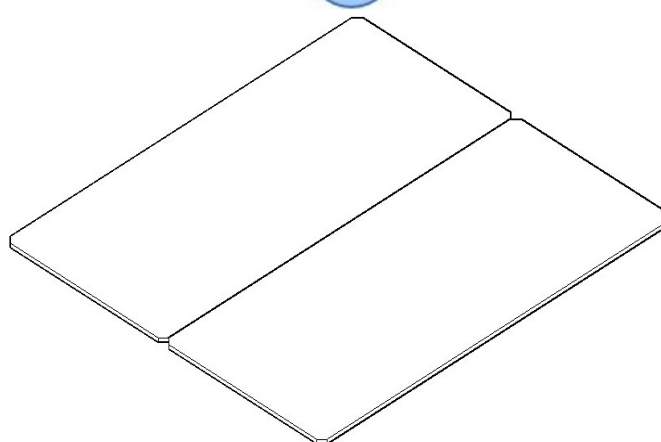

Obrázky uvedené níže jsou ilustrační, design Vaší postele se může lišit.

### PŘÍKLAD BOČNICE PRAVÉ

BP

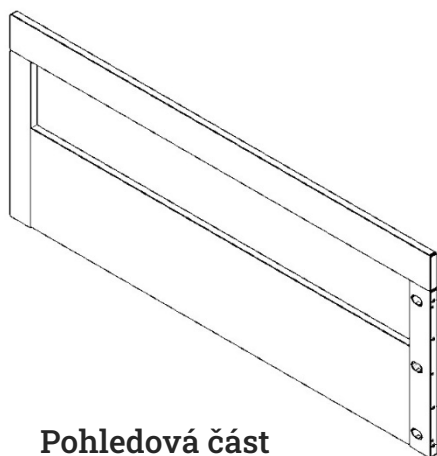

Pohledová část

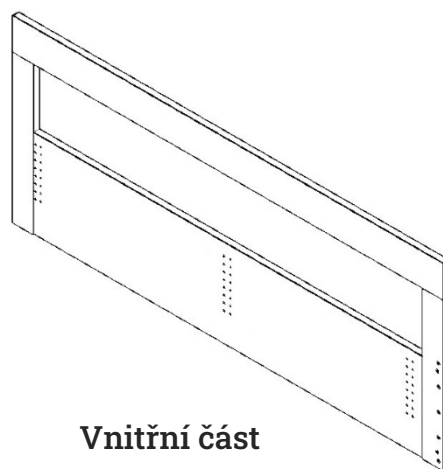

Vnitřní část

### PŘÍKLAD BOČNICE PRAVÉ

BP

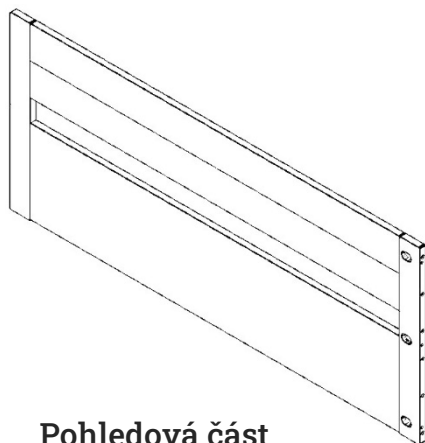

Pohledová část

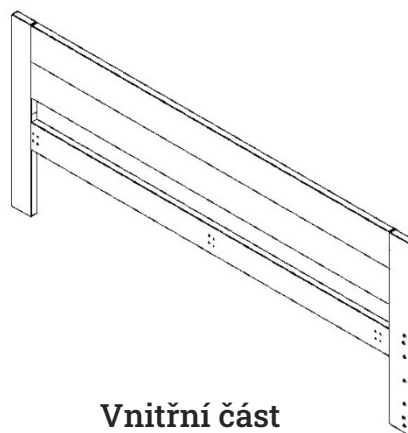

Vnitřní část

### PŘÍKLAD BOČNICE LEVÉ

BL

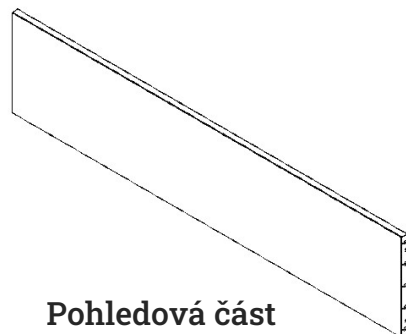

Pohledová část

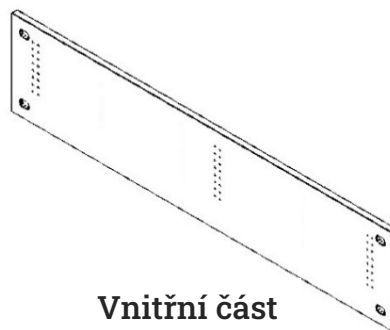

Vnitřní část

### PŘÍKLAD NOŽNÍHO ČELA

NC

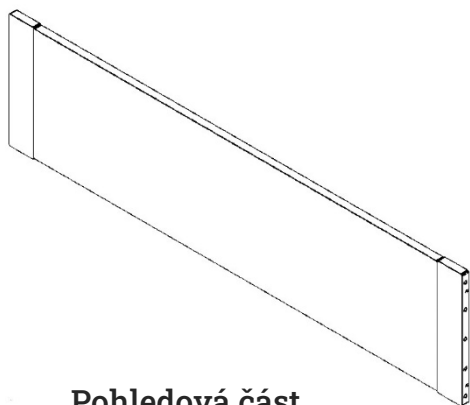

Pohledová část

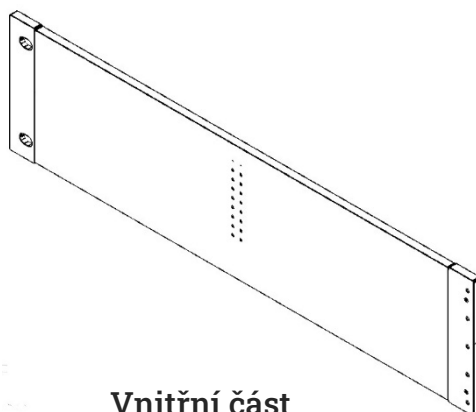







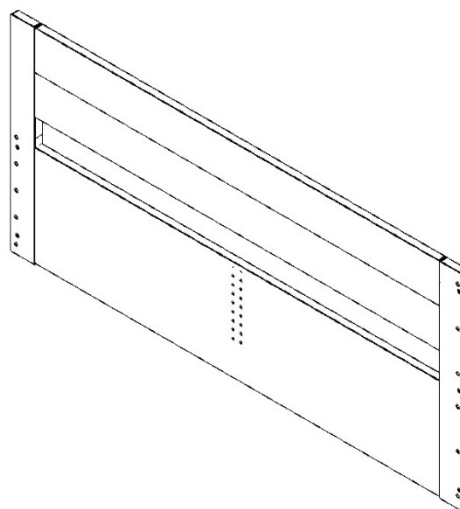
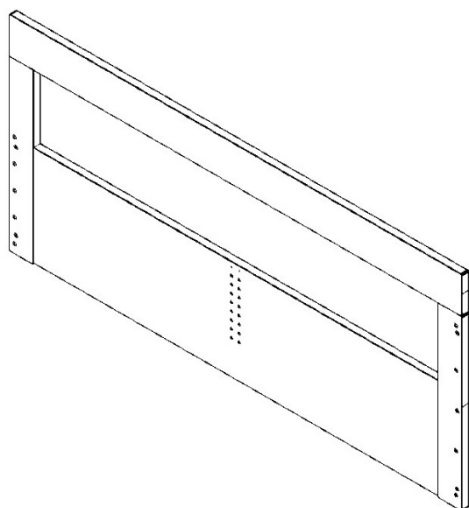

Vnitřní část

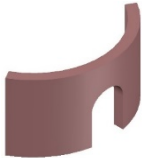
### PŘÍKLAD HLAVOVÉHO ČELA

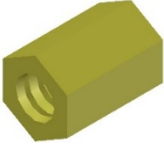
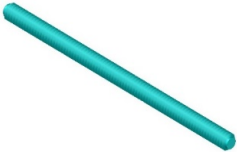
HC

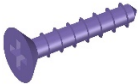

# SOUPIS KOVÁNÍ

 <b>1</b> 9 ks	 <b>2</b> 9 ks	 <b>3</b> 9 ks	 <b>4</b> 9 ks
 <b>5</b> 32 ks	 <b>6</b> 8 ks	 <b>7</b> 2 ks	 <b>8</b> Ø 12 8-26 ks
 <b>9</b> 4x30 4 ks	 <b>10</b> 1 ks		

# SESTAVENÍ POSTELE

# 1.

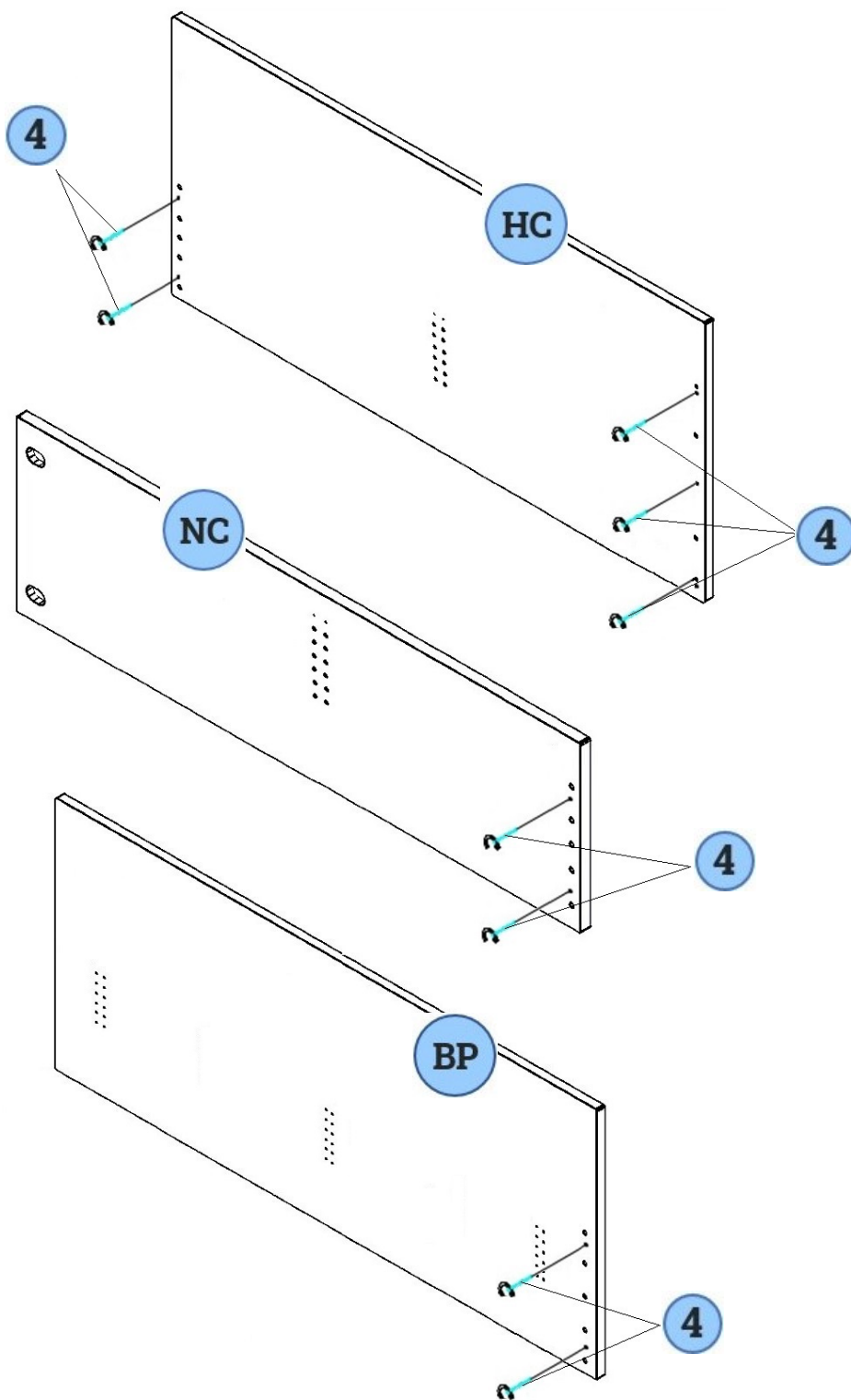

**HC**

1 ks

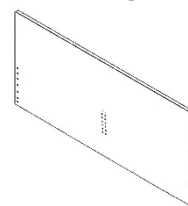

**NC**

1 ks

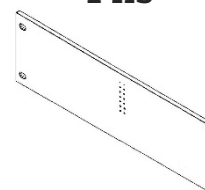

**BP**

1 ks

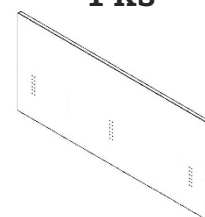

**4**

9 ks



# 2.

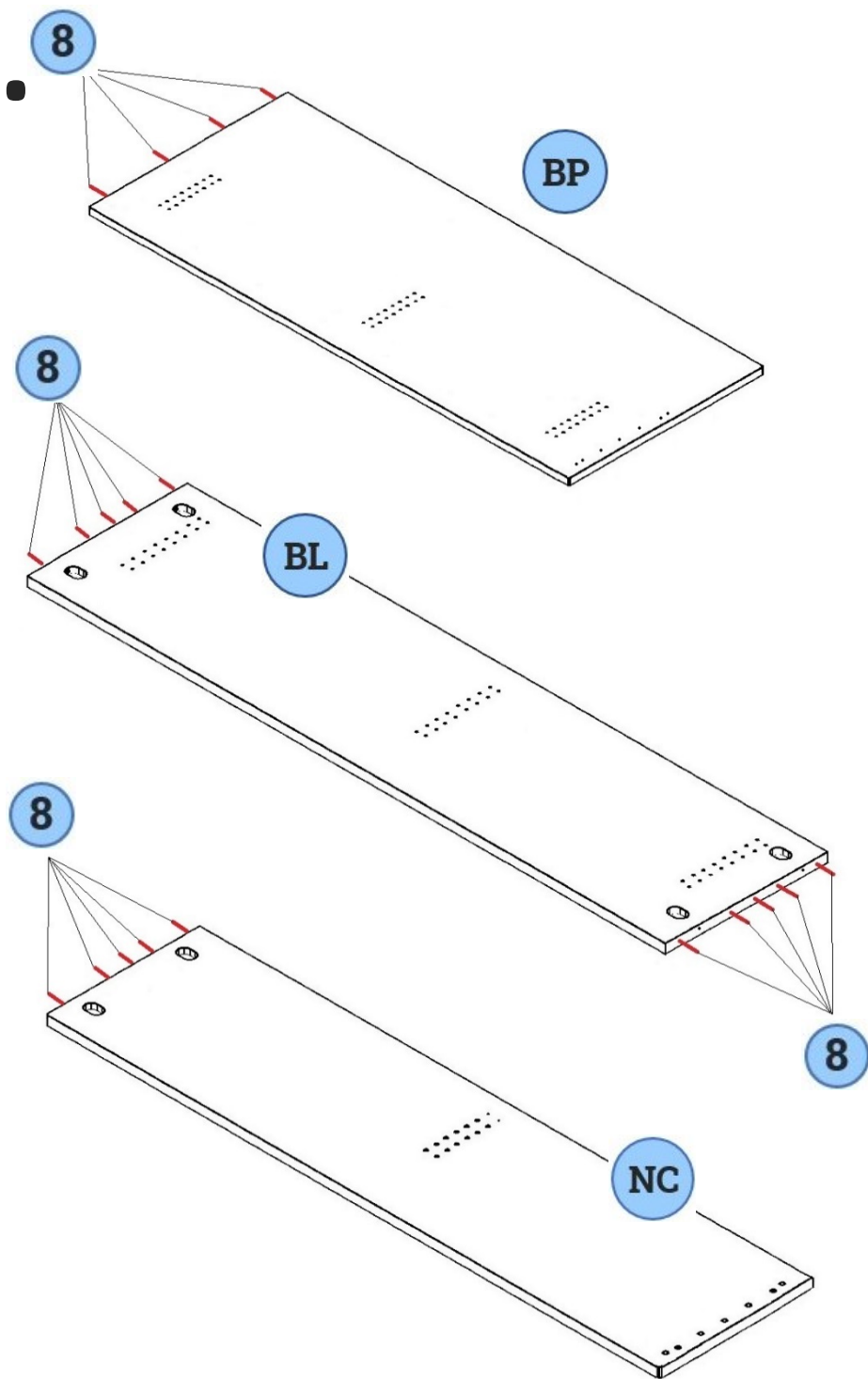

**BP**

1 ks

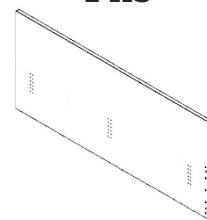

**BL**

1 ks

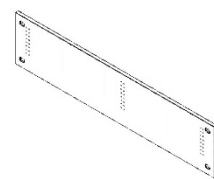

**NC**

1 ks

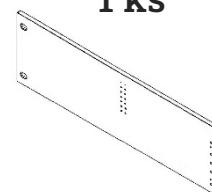

**8**

8-26 ks

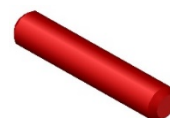

# 3.

Pokud máte postel šířky 90-130 cm, tento krok přeskočte.

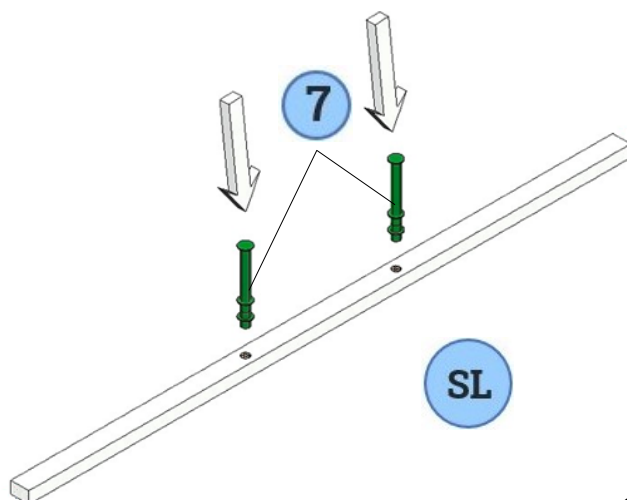

POUŽITÍ NÁSTAVCE NA NOHU NA ZÁKLADĚ VÝŠKOVÉHO UMÍSTĚNÍ LATÍ

SL

1 ks

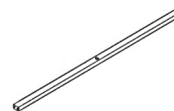

7

2 ks





# 4.

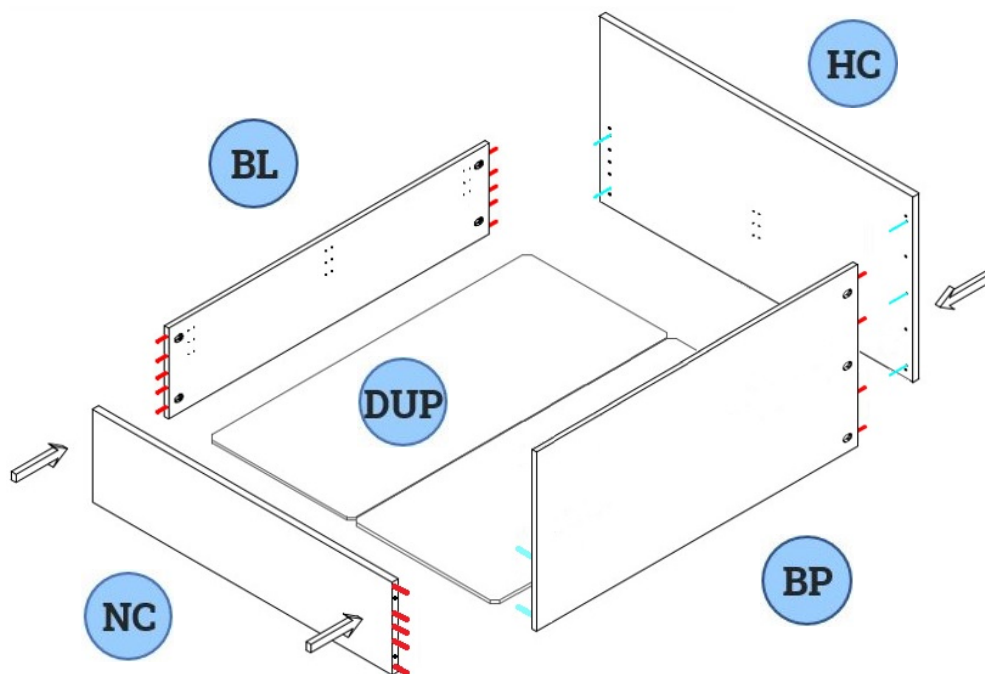

**DUP**

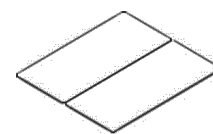

**HC**

**1 ks**

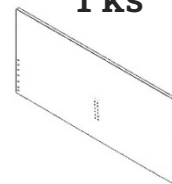

**NC**

**1 ks**

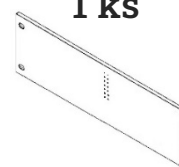

**BL**

**1 ks**

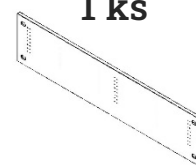

**BP**

**1 ks**

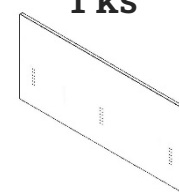

# 5.

Před stažením šroubového spoje pečlivě zkontrolujte, že k sobě dílce bočnice a čela postele dokonale doléhají. V případě nutnosti použijte gumovou paličku. Až poté je možné šroubový spoj dotáhnout.

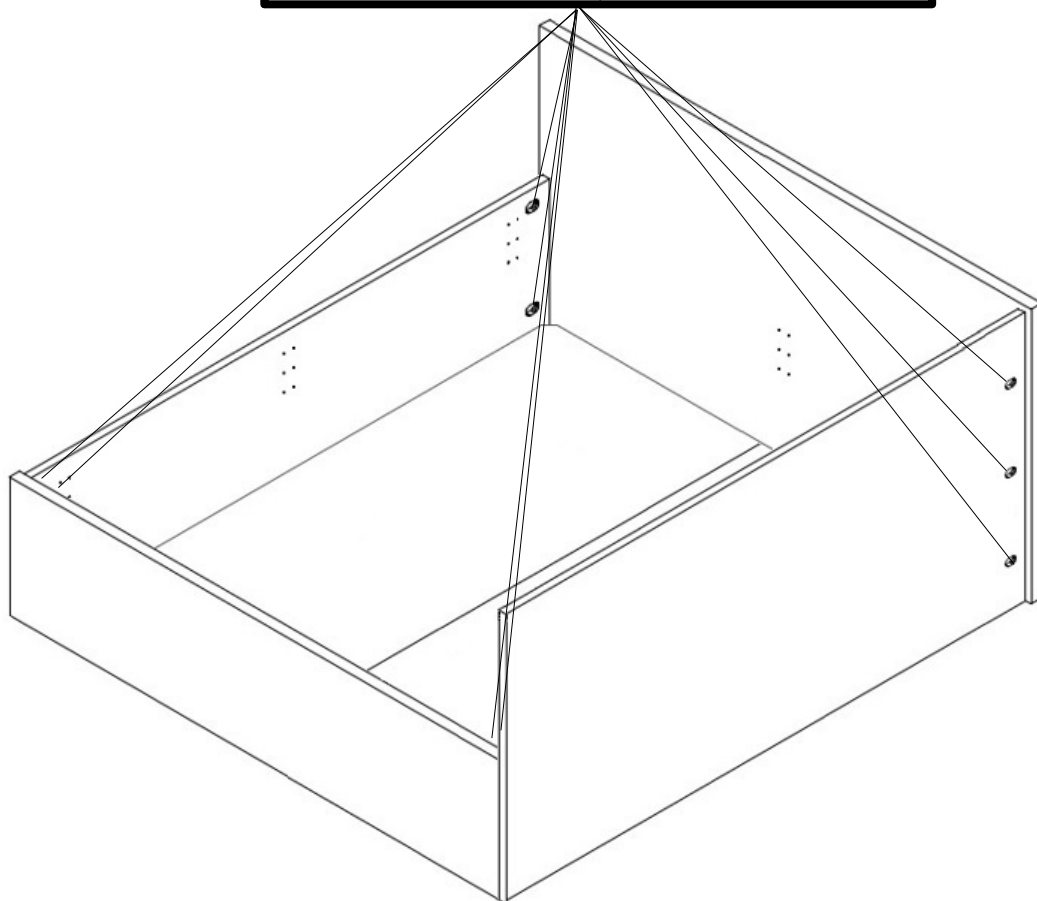
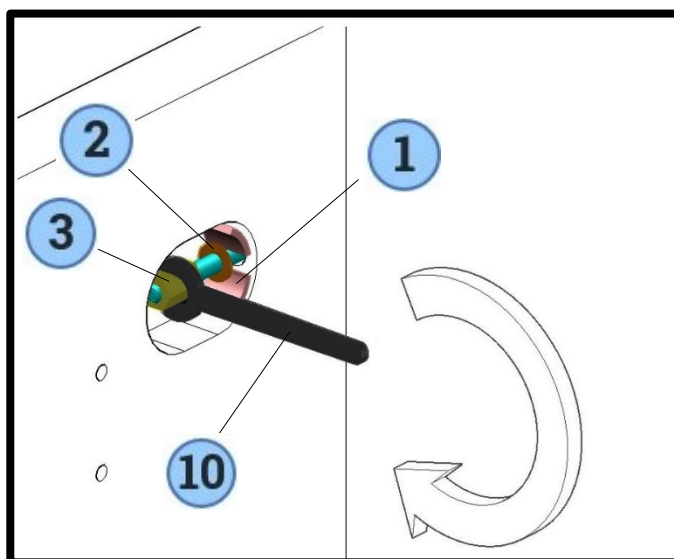

1

9 ks

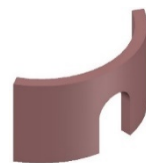

2

9 ks



3

9 ks



10

1 ks



**6.** V tomto kroku dobře zvažte, v jaké výšce bude umístěna středová lať a lať na bočnicích (viz. schéma výšky latí níže na této straně). V případě postele šířky 90-130 cm krok umístění středové lať přeskočte.

### Schéma výšky latí

Lať do bočnic a středovou lať můžete připevnit do několika pozic. Výšková pozice latí ovlivňuje tyto dvě věci:

- 1) Výslednou výšku ložné plochy (pozor, berte v potaz i výšku roštu).
- 2) Kolik cm matrace bude zapuštěno v rámu postele (doporučujeme minimálně 5-8 cm).

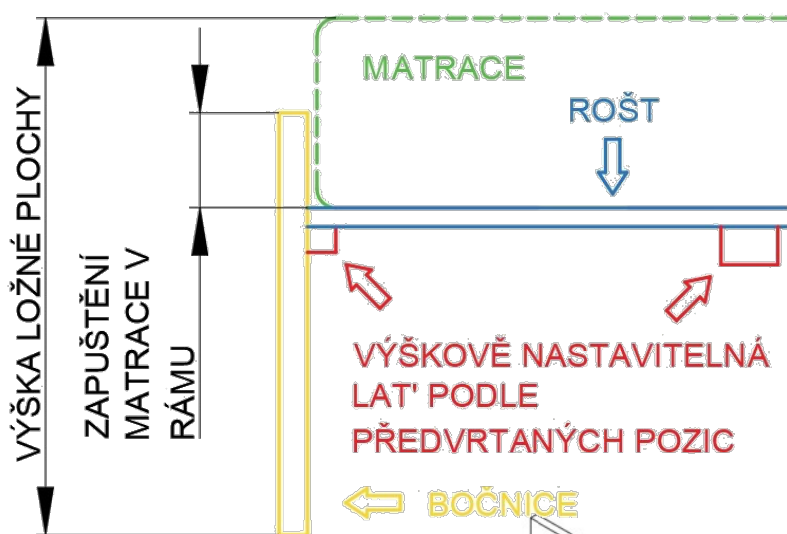

**6**  
8 ks



**5**  
32 ks

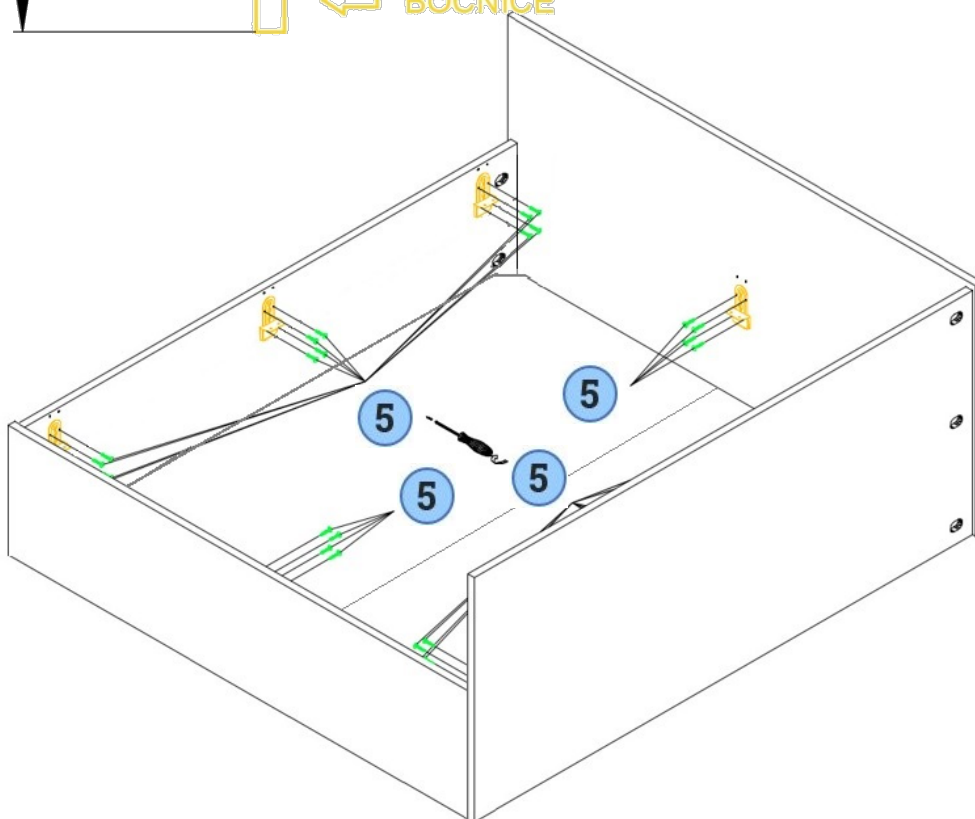

# 7.

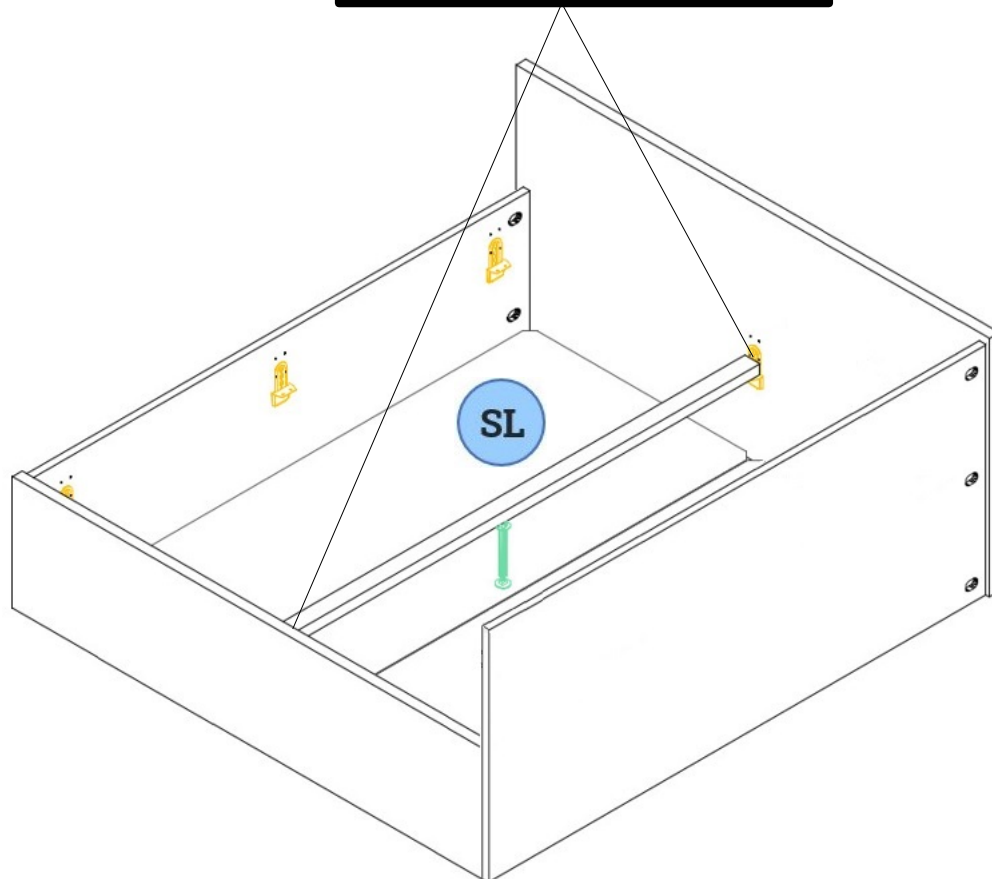
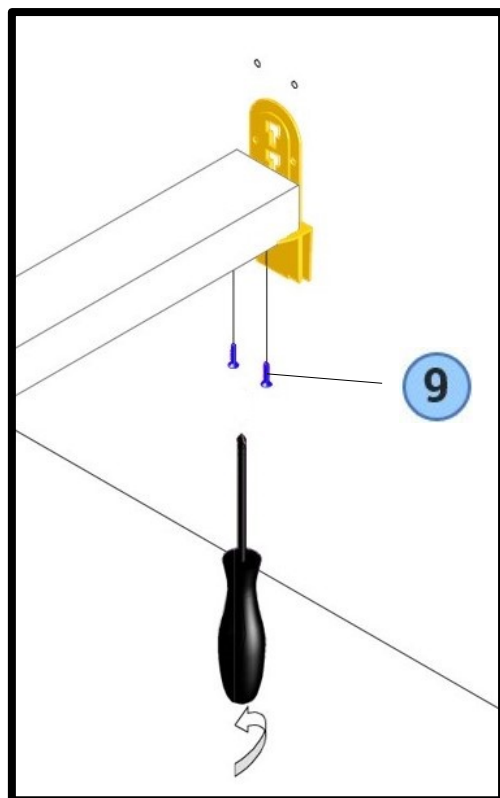

SL

1 ks



9

4 ks

